

# Design and Access Statements



Local Development Framework  
Supplementary Planning Document

  
Sunderland  
City Council

# Design and Access Statements



## Supplementary Planning Document

If you require this document in an alternative format (i.e. braille, large print, audio tape etc.), or in your own language, please contact Jonathan Stewart, or Telephone (0191) 553 1279 Fax (0191) 553 7893

e-mail [jonathan.stewart@sunderland.gov.uk](mailto:jonathan.stewart@sunderland.gov.uk)

October 2008

# Design and Access Statements

A guide to the preparation of Design and Access Statements for submission in support of planning applications to Sunderland City Council.

## Contents

<b>1.0</b>	<b>Introduction</b>	<b>5</b>
1.1	Purpose of this guide	5
1.2	Status of the Guide	5
1.3	Statements	5
1.4	When are Design and Access Statements required?	6
1.5	Why are Design and Access Statements needed?	6
<b>2.0</b>	<b>What is good design?</b>	<b>8</b>
2.1	Building Design	8
2.2	Urban Design	8
<b>3.0</b>	<b>Writing Statements</b>	<b>9</b>
3.1	Full Planning Applications	9
3.1.1	Design and Access Statements for small scale developments	9
3.1.2	Comprehensive Design and Access Statements	12
3.2	Outline Applications	19
3.3	Design and Access Statements Accompanying Applications for Listed Building Consent	20
3.4	Pre-application Enquiries	22
<b>4.0</b>	<b>Presentation</b>	<b>23</b>
<b>5.0</b>	<b>Further Guidance</b>	<b>26</b>
<b>6.0</b>	<b>Glossary</b>	<b>27</b>
<b>7.0</b>	<b>Images within the document</b>	<b>28</b>



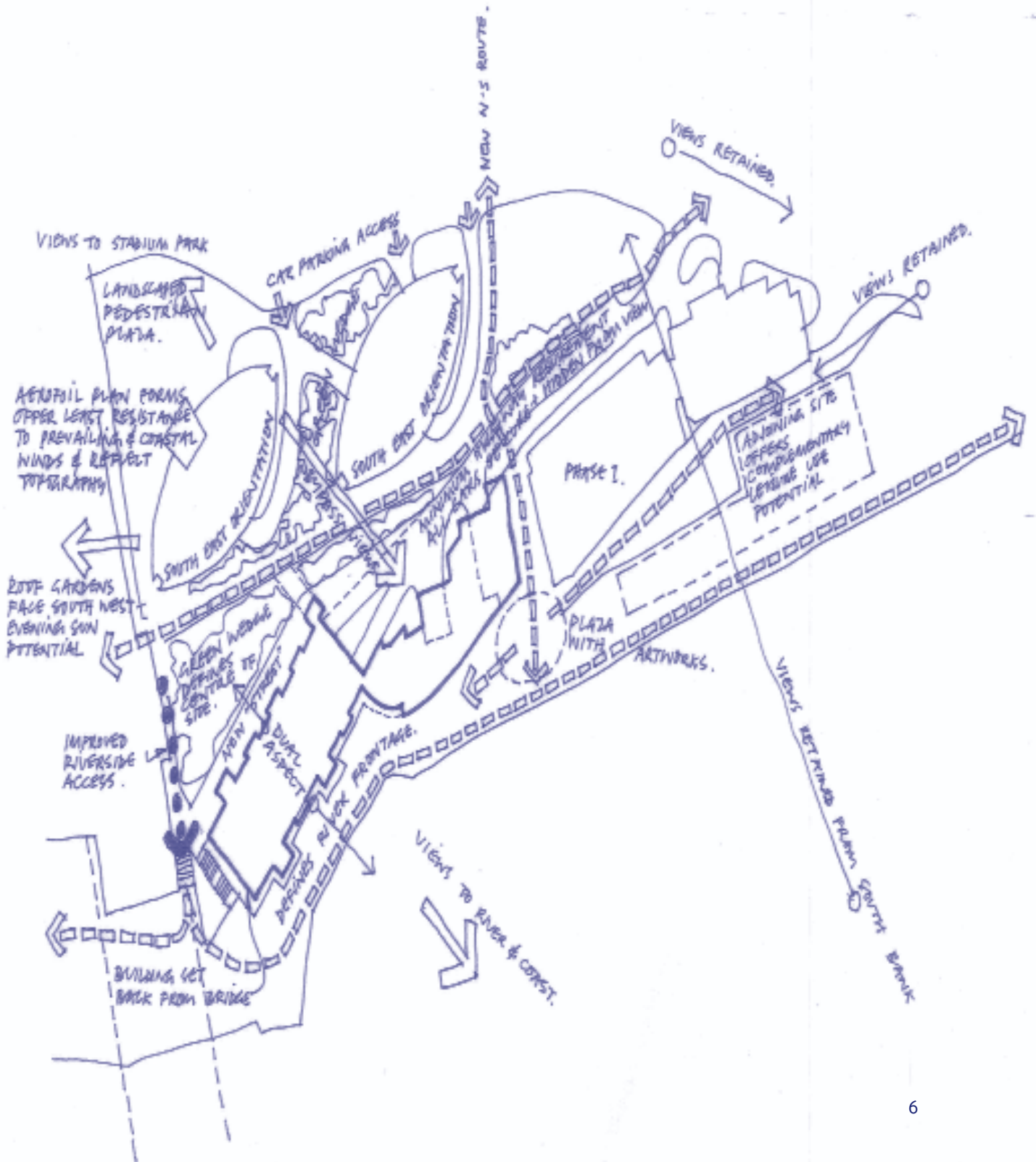

# 1.0 Introduction

In May 2006, the government introduced changes to the process for making a planning application. The circular *Guidance on changes to the development control system* sets out the formal requirements, which became effective on the 10th of August 2006. Legislation is now in place that requires developers to submit Design and Access Statements in support of most new planning applications. The aim of these changes is to help make sure we create high-quality places that are easy for everyone to use.

The City Council and Central Government are committed to achieving the highest possible standard of design in all new developments. In addition to explaining the changes made to the planning application process, this document also outlines key principals that will inform the design process and suggests a structure for supporting information to be included in a Design and Access Statement.

Design is a legitimate and important consideration in planning decisions. Planning Policy Statement 1 states:

"Good design ensures attractive, usable, durable and adaptable places and is a key element in achieving sustainable development. Good design is indivisible from good planning.... Design which is inappropriate in its context or which fails to take opportunities available for improving the character and quality of an area and the way it functions, should not be accepted."

Design is a material consideration in determining planning applications. The City Council may refuse an application, and defend its decision at appeal, solely on design grounds.

## 1.1 Purpose of this guide

The purpose of this document is to assist all those concerned with new development that requires planning permission. It also aims to assist the development control process and to help assess the appropriateness of planning

applications in conjunction with relevant Local Development Framework (LDF) policies, supplementary planning documents (SPDs) and relevant national guidance and legislation. This guide is intended as best practice guidance for the City of Sunderland to accompany the government circular *Guidance on changes to the development control system*.

This SPD is one of a number of documents produced by Sunderland City Council to encourage high standards of design quality in the built environment.

## 1.2 Status of the Guide

The guide will be taken forward as a SPD and will become part of the LDF and supplement the policies contained within the core strategy of the LDF and other development plan policies. In particular the guidance amplifies Unitary Development Plan (UDP) Policy B2 (Built Environment) and UDP Alteration No 2 Policy B2A (Sustainable Urban Design).

## 1.3 What are Design and Access Statements?

A Design and Access Statement is a short report accompanying and supporting a planning application that explains the design thinking behind the proposal. The project team (applicant, urban designer, architect, landscape architect, planning consultant etc) should explain and illustrate how the proposed design solution has been informed by the key principles of good design. The Design and Access Statement should illustrate the key design and access concepts of the project and demonstrate how it has been informed by a thorough appraisal of the site and its context as well as relevant planning policies and design guidance. A single statement should cover design and access, this will allow applicants to demonstrate that an integrated

approach has been adopted, that will deliver inclusive design and address a full range of access considerations through the design process. Much of the research that is required for the design section will help to inform the decisions made regarding access, and vice versa.

A Design and Access Statement will accompany a planning application but is not included as part of the application itself. The guidance or aspirations contained within a statement can therefore be linked to a planning decision by the council through the use of planning conditions, if developers are required to follow them.

#### 1.4 When are Design and Access Statements required?

The government's circular: *Guidance on changes to the development control system* sets out when Design and Access Statements are required:

*'As set out in the GDPO, design and access statements will be required for all planning applications except for:*

- *a material change in the use of land or buildings, unless it also involves operational development.*
- *engineering or mining operations.*
- *development of an existing dwelling house, or development within the curtilage of a dwelling house for any purpose incidental to the enjoyment of the dwelling house, where no part of that dwellinghouse or curtilage is within a designated area. "Designated area" means a National Park, Site of Special Scientific Interest, Conservation Area, Area of Outstanding Natural Beauty, World Heritage Site and the Broads.*
- *applications relating to advertisement control, tree preservation orders or storage of hazardous substances.'*

It is important that statements are written specifically for the development that they will

accompany. Statements do not need to be excessively protracted documents, but the complexity of the development should be reflected in the level of detail that they contain.

#### 1.5 Why are Design and Access Statements needed?

Design and Access Statements help to ensure that future development proposals are based on an appropriate design process and a sustainable approach to access. They provide benefits to the applicant, designers, architects and consultants as well as the City Council and members of the local community. The documents are a communication tool and should increase design and access awareness, provide a sound basis for constructive negotiations and lead to high quality development. The document will also help individuals and the local community to understand why a particular design approach has been adopted.

#### Applicants

A Design and Access Statement allows applicants to explain the design of their scheme in a structured manner. It is an opportunity to demonstrate how the proposed design solution has been developed, how it makes a positive response to the site and its context and how access has been given due consideration. A design statement will therefore act in support of a planning application.

#### Sunderland City Council

The submission of a Design and Access Statement will help the local authority understand how a particular design solution has been developed and how a thorough appraisal of the site and its context has informed the design process and access solutions proposed. A clearly presented Design and Access Statement will contribute to efficient and effective decision making and lead to an improved form of development.

## Members of the Public/Local Community

Statements will help individuals, the local community and other stakeholders to understand why a particular design approach has been adopted by explaining the process that has led to the final scheme. The statement should enable them to involve themselves more directly in the planning process without the need to interpret plans that could be technical or confusing. As statements will be available alongside the application for viewing by interested parties, they should avoid planning jargon or unnecessary technical language. This will help to increase certainty for those affected by development and should improve the level of trust between communities, developers and planners.

Development schemes that are not informed by a thorough understanding of their context will often be poorly designed, and may result in the exclusion of some members of society. A major part of a Design and Access Statement is the explanation of how local context has influenced the design.



Highgate, Durham - Design philosophy developed following a detailed townscape study of the historic residential streets in Durham City.



The Place, Sunnyside - high quality contemporary architecture alongside a listed property. The new building respects the scale and proportions of the historic properties and complements the established building materials with the use of coloured glazed louvres.



## 2.0 What is good design?

Good design is not primarily a question of style and taste. Rather, it is the adherence to a set of time honoured principles that determine whether or not a building or place works well for the community.

### 2.1 Building Design

Key aspects of good building design include:

**Appearance:** The building should demonstrate a high level of architectural ambition and be excellent in itself. The plans, sections, structural elements, environmental services, materials and detailing should be integral to the overall architectural expression of the building.

**Context:** The building should make a positive contribution to the character and appearance of its neighbourhood. It should respond to the natural patterns of movement in and around the site, take advantage of potential views and vistas and be orientated to maximise efficiency of energy use.

**Sustainability:** It should be constructed using efficient building techniques using materials from sustainable sources. The design should minimise the use of non-renewable energy sources.

**Maintenance:** The building should be designed to minimise repair, maintenance, energy and security costs. The design should take account of all estimated costs over the whole life of the building.

**Operation:** The building should be accessible to all members of the community, easy to move around, flexible, adaptable and comfortable, attracting a favourable response from all its users.

### 2.2 Urban Design

Key objectives of good urban design include:

**Character:** To promote townscape and landscape character by responding to and reinforcing locally distinctive patterns of development, landscape and culture.

**Quality of the public realm:** To promote public spaces and routes that are attractive, safe, uncluttered and work effectively for all in society, including disabled and elderly people.

**Ease of movement:** To promote accessibility and local permeability by making places that are accessible to all, connect with each other and are easy to move through, putting people before traffic and integrating land uses and transport.

**Legibility:** To promote legibility through development that provides recognisable routes, intersections and landmarks that help people find their way around.

**Adaptability:** To promote adaptability through development that can respond to changing social, technological and economic conditions.

**Diversity:** To promote diversity and choice through a mix of compatible developments and uses that work together to create viable places that respond to local needs.



Contemporary residential dwelling - Boyd Copy Architects, Alma Road, Dublin.



## 3.0 Writing Statements

The level of detail required for a design and access statement will depend on the scale, context and impact of the development that is proposed. In some instances an applicant may be requested to produce a pre-application design statement to explain the design principles on which the proposed development is based. This will enable the City Council to provide an informed response in respect of the main design and planning issues. In addition to the extra requirements for full applications, the regulations regarding outline applications and listed building consent have also changed, as discussed later in this section.

### 3.1 Full Planning Applications

#### 3.1.1 Design and Access Statements for small scale developments

Sunderland City Council consider that the following elements are the minimum requirement for a design and access statement in support of a full planning application. The level of detail included within the DAS should be relevant to the scale of the development. Applicants will be expected to follow the design process described below and provide evidence to show that this has been done.

**Project Brief** - should set out the aims and aspirations of the client and demonstrate how the principles of good design will be applied. The project brief should include statements relating to development proposals, method of procurement, sustainability, functional requirements and community.

**Policy Review** - should identify relevant planning policies and guidance and demonstrate how they have informed the development proposals. Relevant policy or guidance may be contained within National and Regional Policy Guidance, Planning Policy Statements, Planning Policy Guidance Notes and Regional Planning Guidance. The requirements and guidance of other public

bodies may also need to be taken into account. All areas within Sunderland are covered by the UDP, which was adopted in 1998. The UDP will be replaced with the LDF. A design and access statement should refer to or quote the relevant planning policies that apply to the development, including those applicable to the wider area as well as those specifically relevant to the site itself.

**Site Appraisal and Survey** - the starting point for every development is a detailed study of its physical context. Typically a site appraisal and survey will involve two key stages:

- Desktop Study - the collection of data such as plans showing the site and its surrounding area, aerial photographs and other relevant information. Some of this work may have already been undertaken as part of the policy review
- Site Survey - the collection of data such as townscape character, context, views and vistas and patterns of movement. The survey will include a comprehensive photographic record of the site and its context

**Design Concept** - should include a written statement and illustrations in sketch form to demonstrate how the project brief, policy review and site appraisal have informed the principle design concepts of the development. Particular emphasis should be given to demonstrating how the key objectives of good urban design have been translated into the development proposals.



Artists impression of development proposal - elevation treatments.

The Design Concept should include details on the following:

**Use** - The use or mix of uses proposed:

- Will the use broaden local choice, contributing towards a diverse yet cohesive community?
- Will the use attract many people - if so, is it easily accessible to all users to minimise travelling?
- Is the use compatible with others existing?
- Will it create an appropriate mix?
- Can it be easily adapted?

**Amount** - The number of buildings or floor space etc.

- How much development is proposed?
- How appropriate is its density and quantity to the existing area - will it overwhelm existing character?
- How will the buildings be distributed on the site and in relation to the surroundings?
- Why?

**Layout** - The way that the buildings, routes and open spaces are arranged, explained in relation to use, environment within and around the site and access:

- Is the design an efficient purposeful use of space for all users? Is it logical, legible and user-friendly?
- Are public spaces practical, safe, overlooked and inclusive?
- Are private spaces adaptable, secure and inviting?

**Scale** - This refers to the size of the buildings that form the proposed development, especially in relation to what is around them:

- Will the buildings sit comfortably with their surroundings?
- Is the scale in keeping with the character of the area?

- Does it fit comfortably with the existing skyline?
- Is the chosen scale suitable for the use proposed?

**Landscaping** - This means the planting, landform and biodiversity interest within the proposal. Landscaping should be integral to any design from the start and not a 'fig leaf' to hide poor design:

- Does the landscaping support local character and image?
- Does it help meet specific aims for the site such as defining private and public spaces, making them safe, attractive and successful?
- Will local biodiversity be harmonised with human use, including for health and recreation?

**Appearance** - This covers issues like architecture, materials, decoration, colour, texture and workmanship. New developments do not need to overpower their context:

- Does the design respond to the key opportunities and constraints of the area?
- Is the quality of materials and detailing good? Would people be proud to live or work there now and in the future?
- Is there a sense of place? Is the character pleasing? Is it tailor-made for the locality rather than 'off the peg'?
- How will the development visually relate and respond to its surroundings? Does it fit in, respect, reflect or enhance its context? Does the design cherish local distinctiveness?

### Access

All proposals, whether for new developments or alterations to an existing building, should consider the implications of providing inclusive access from the start of the design process. The details of this should be submitted as part of any application to reflect this process.

Access refers to the links between the site and local transport network, and also to social inclusion. Within the design and access statement, access issues and constraints should be explored. An awareness of national and local policy would also be expected and results of consultation and expert advice received should be mentioned.

- Will the place be safe and easy for everyone to move around?
- Have the physical access needs of all sections of the community been taken into account, and has the policy approach and consultation process been clearly described?

- Is the development well linked into surrounding transport networks, making it accessible by more environmentally friendly modes such as public transport, cycling and walking?

Overall, the statement needs to include both potential aspects of access i.e. physical access and social inclusion. That is not to say they are separate and the statement should show that all access issues have been considered together.

### Vehicular and transport links

- Why have the access points and routes been chosen?
- How does the site respond to road layout and public transport provision?

### Inclusive Access

- How can everyone get to and move through the place on equal terms regardless of age, disability, ethnicity or social grouping?



St Peter's Metro Station - Developers should consider how their scheme will link into the local public transport system.

### 3.1.2 Comprehensive Design and Access Statements

The following checklist presents a framework for the preparation of a fully detailed statement. It will help identify priorities and ensure nothing of importance is omitted. This is a comprehensive checklist aimed at major developments with a significant environmental impact, for example 8 dwellings or more.



Thomas Hawksley Park, Humbleton Hill Sunderland - Example of high quality residential development.

#### A Background Information

Background information will generally include:

- The project team including architect / developer / urban designer / agents / advisors etc
- Brief description of the site including ownership details, site history, address etc.
- 1:1250 location plan
- Photographs of the site (including aerial photograph) and the surrounding area (this information may form part of the site appraisal)
- Brief project description

#### B Project Brief

The project brief should clearly set out the aims and aspirations of the client and demonstrate how the principles of good design will be applied. Generally, it will include a series of statements relating to the following issues:

##### Development proposals

- What type of development is proposed?
- What is the mix of uses?
- What is the size and form of the development? For residential developments, how many units are proposed and what density will be achieved?
- Is this a phased development? Are there any further developments proposed in the surrounding area?

##### Method of procurement

- What measures are in place to ensure a commitment to excellence in design and construction?
- How was the design team selected (architect, landscape architect, urban designer, planning consultant etc.) and what experience do they have?
- How will the contractor be selected?
- What is the project programme?

##### Sustainability

- Sustainability is a concept, which should permeate the whole design process. The client brief should demonstrate how the concept of sustainability, in its widest sense, has been identified as a key aim and objective of the development.

##### Design quality

- The design quality of all buildings and open spaces is fundamental to the success of any development. The design brief should include a statement referring to the client's aspirations of achieving design excellence.



### Functional requirements

- What are the principal functions of the development?
- How will the development meet the functional requirements of all its users?

### Accessibility

- How will the development promote accessibility and fulfil access requirements of all its users?
- How have access requirements been considered from the start and how have they informed the design process?

### Community

- How will the views of the local community inform the design process?
- How will the development be of benefit to the wider community and improve social cohesion?
- What measures are in place to design out crime?

## C Site Appraisal

The starting point for every development is a detailed study of its physical context. A site appraisal will involve the collection of qualitative and quantitative data to establish a comprehensive profile of the site and its context.

Typically a site appraisal and survey will involve two key stages:

### Desktop Study

A desktop study will include the collection of data such as plans showing the site and its surrounding area, aerial photographs and other relevant information e.g. the identification of utilities and services, land contamination, public transport, listed buildings, sites of archaeological importance and sites of nature conservation

interest etc. It will also involve identification of relevant land use planning policies contained within the Local Development Framework or Supplementary Planning Documents.

### Site Survey

A site survey will involve the collection of data, such as townscape character, context, views and vistas, and patterns of movement. The survey will include a comprehensive photographic record of the site and its context.

A comprehensive checklist for a site survey may include the following:

### Context

- What land use does the development site have?
- What are the adjacent land uses?
- What are the local land use policies on the site and the surrounding area?
- What is the development site area in hectares?
- What type of infrastructure exists on and around the site?
- What is the capacity of existing services available such as gas, electricity, water etc?
- What facilities are within close proximity of the site such as schools, shops, public transport etc?

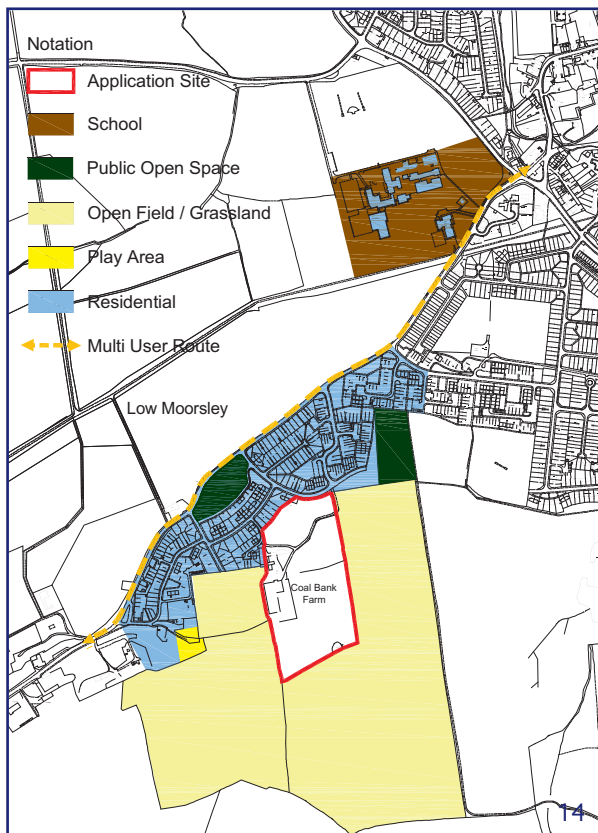

Site Plan showing adjacent land uses

### Geology, Contamination and Pollution

- What are the soils and geology of the area? Is a geological survey required?
- Have the geological interests around the development site been properly considered?
- Where necessary, are measures in place to ensure geological features/ exposures are protected and enhanced with appropriate access and interpretation?
- Is the ground contaminated or has the site had a previous use that may have resulted in ground contamination? Is a ground contamination survey required?
- Is there a history of mining in the area?
- Is the proposed development in an area where there are unacceptable levels of air or water pollution?
- Do any parts of the area or site suffer from noise? Is a noise survey required?

### Landscape Character

- What are the physical characteristics of the site e.g. topography, orientation, existing buildings and structures, watercourses and boundary etc?
- What is the ecology of the site and the surrounding area?
- What is the microclimate of the site?

- What boundaries and barriers are there at the edge of (or within) the area or site?
- What is the landscape character of the surrounding area or site? Further guidance on defining landscape character type and landscape character areas can be found at: [www.countryside.gov.uk/lar/landscape/cc/landscape/publication](http://www.countryside.gov.uk/lar/landscape/cc/landscape/publication)

### Biodiversity and Ecology

- Has proper consideration been given to sites and areas of nature conservation and geological importance
- How will natural features such as ponds and trees be integrated within the site?
- Can the proposed removal of wildlife habitats be sufficiently justified?
- Are there sufficient measures in place to avoid harm to biodiversity and ecology outside the development site?
- Has consideration been given to opportunities for habitat creation such as creation of ponds, tree planting and boundary hedges?

### Protected Species

- Has proper consideration been given to the possible presence of protected species such as Great Crested Newts and Bats? A detailed and suitable species survey may be required
- Where protected species have been identified, does the development meet the legislative requirements set out in PPS9, ODPM Circular 06/2005 and Habitats Regulations (amended 2007)?

### Built Form

- How did the site and the surrounding area develop? What are the ages of buildings and structures?
- What sort of street layout does the area have?
- Is the site of archaeological interest? Is an archaeological assessment or survey required?
- What is the distinctive character of buildings and structures on the site and the surrounding area?
- What distinctive architectural features and building techniques contribute to the character of the area?
- Is any part of the site in a Conservation Area?
- Are any buildings or structures listed for their architectural or historic value?

## Movement

- What is the pattern of pedestrian movement in and around the site?
- What is the area's road network?
- What public transport routes and stops serve the area?
- What facilities for cycling are there?
- What current proposals for roads, footpaths or public transport might be relevant to future development?
- Will a green travel plan be required?
- Have opportunities to integrate the development with existing cycle and pedestrian networks been explored?

## Views and Vistas

- What is visible from particular points within or around the site?
- Are there any notable views or landmarks?
- What buildings or structures (on or visible from the site) stand out from the background buildings?
- Are there places or features within or at the edge of the site which are seen (or could potentially be seen) as gateways to it? are there any existing Public Rights of Way or Bridleways?

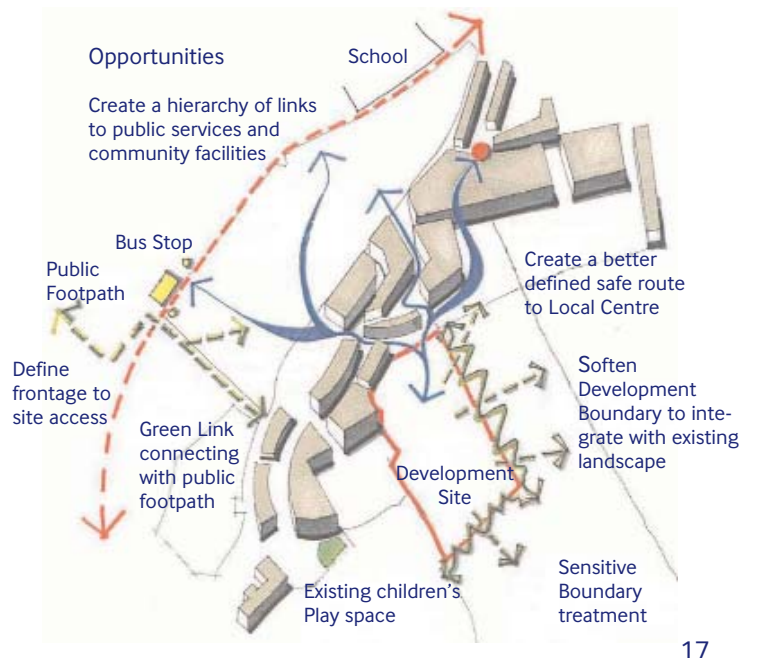
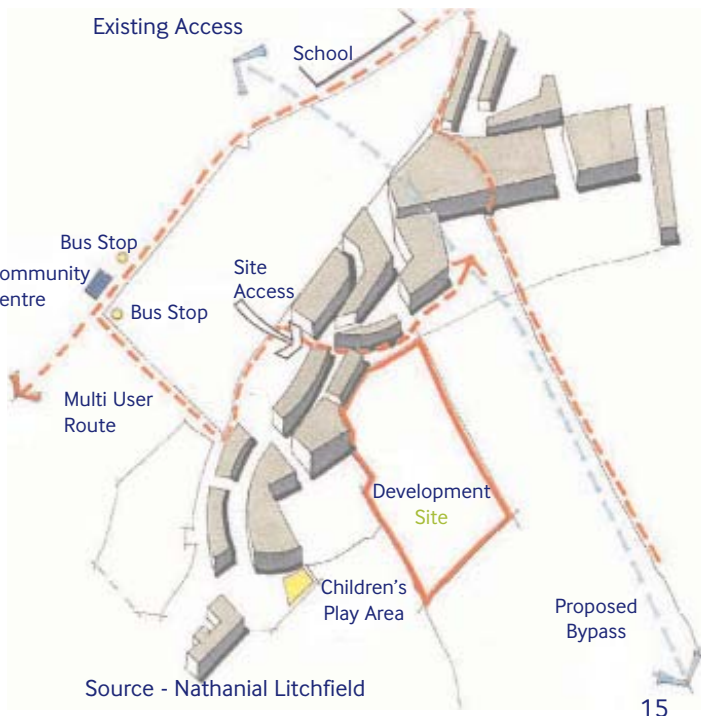
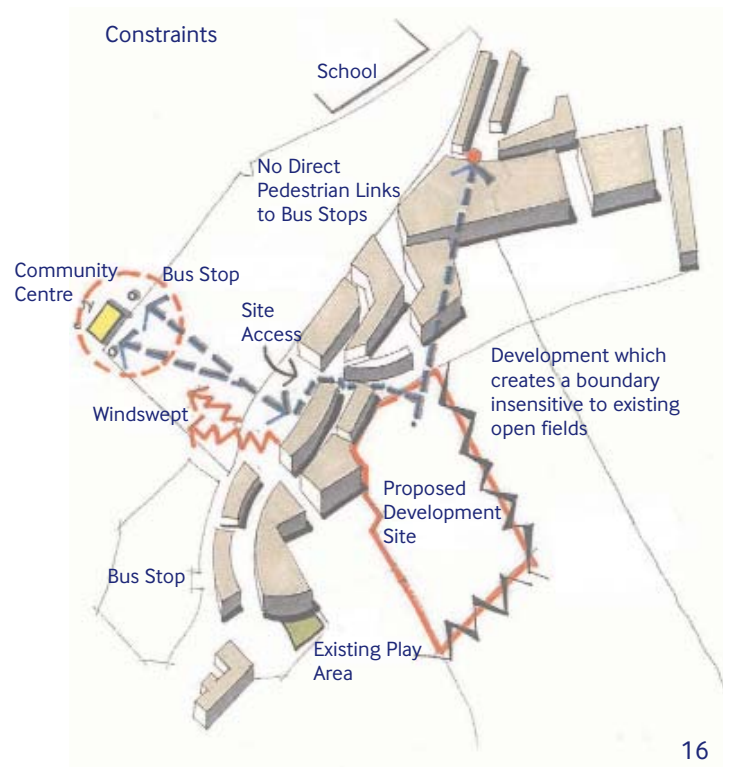

## D Policy Review

The Design Statement should identify relevant design guidance and planning policies and demonstrate how they have informed the design of the development proposals. Relevant design guidance and policy documents include:

All forms of development:

- Unitary Development Plan - Adopted 1998 (City of Sunderland)
- Unitary Development Plan 1998 - (Alteration No.2) Central Sunderland - Additions and Amendments to Adopted UDP Policies (City of Sunderland)
- Sunderland Central Area Urban Design Strategy (City of Sunderland)
- Building in Sustainability - A guide to Sustainable Construction and Development in the North East (Sustaine)
- Urban Design Compendium (English Partnerships / Housing Corporation)
- Planning Policy Statement 1, Delivering Sustainable Development (ODPM)
- Better Civic Buildings and Spaces (CABE)
- Design Review (CABE)
- Better Public Buildings (DCMS)
- By Design - Urban Design in the Planning System (DTLR)
- Manual for Streets (DfT / Communities and Local Government)
- Building in Context (CABE / English Heritage).
- Guidance on Tall Buildings (CABE / English Heritage)
- Celebrating Innovation (CABE / Rethinking Construction)
- The Value of Urban Design (CABE / Thomas Telford)
- What Makes a Good Building (Royal Fine Art Commission)
- Safer Places - The Planning System and Crime Prevention (ODPM)

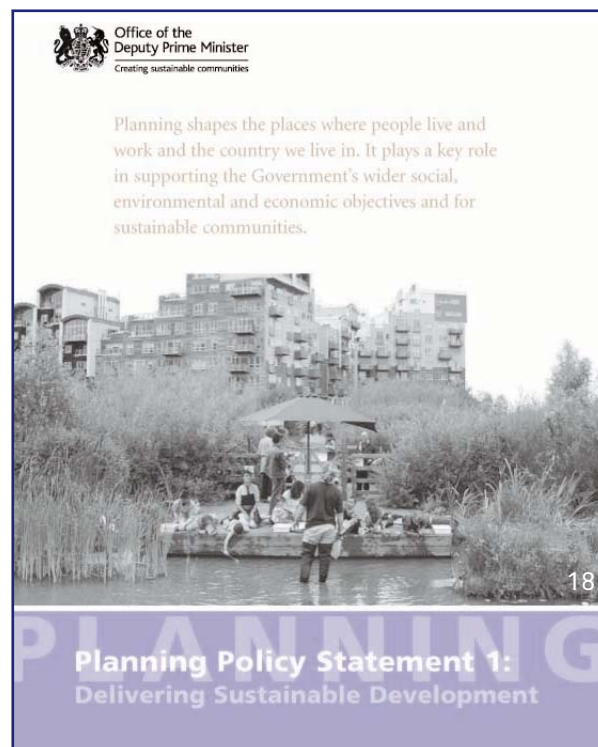

### Residential developments:

- Planning Policy Statement 3 Housing. (DCLG)
- Residential Design Guide Supplementary Planning Document (City of Sunderland)
- By Design: Better Places to Live, A Companion Guide to PPG3 (DTLR)
- Code for Sustainable Homes (DCLG)

### National and Regional Agencies and Public Bodies:

- Commission for Architecture and the Built Environment
- Department for Communities and Local Government
- Regional Development Agency
- Countryside Agency
- English Heritage
- English Partnerships
- Environment Agency
- Police Authority
- English Nature



## E Design Concept

This section will include a written statement and illustrations in sketch form to demonstrate how the project brief, policy review and the site appraisal have informed the principle design concepts of the development. Particular emphasis should be given to demonstrating how the key objectives of good urban design have been translated into the development proposals. Matters which may be included are set out below.

**Use** - The planning application will need to say what the development would be used for. The statement should explain how this will fit in with the area and how the uses planned will offer the things people need and want. The statement should also show that the applicant has understood the access needs of different uses and made sure the design will allow for inclusive access.

**Amount** - The statement must explain and justify the amount of development being proposed, for example the number of residential units or floor space for a proposed use. The statement must explain and justify density decisions, not only against national and local policy, but also in terms of site-specific physical, social and economic constraints or opportunities. The design and access statement should explain and justify the amount of development for any proposed use and how this will be distributed across the site.



19

A variety of techniques can be used to illustrate the proposed development.

**Layout** - It will be necessary to explain the way in which buildings, routes and open spaces (both private and public) are provided and sited in relation both to each other and buildings and spaces surrounding the development, and how these relationships will help to create safe and vibrant successful places. Planning Policy Statement 1 (PPS1) is clear in the requirement of new developments to create safe and accessible places where crime and fear of crime will not undermine quality of life. Statements should therefore demonstrate how crime prevention has been considered as an integral part of the design proposal. The statement should explain how the development provides high quality amenity areas and what measures have been adopted to avoid the public realm being dominated by parked vehicles.

**Scale** - The height, width and length of a building or buildings should be demonstrated in relation to its/their surroundings. The design and access statement should explain and justify the scale of buildings proposed plus the size of particular building elements such as entrances and facades with regard to how they will relate to the human scale.

**Landscaping** - The design and access statement should explain and justify the proposed landscaping scheme. In particular it should be shown how the hard and soft landscaping measures proposed for a development and the treatment of public and private spaces will enhance or protect the amenities of the site and the area in which it is situated.

**Appearance** - The design and access statement should explain and justify the appearance of a proposal (e.g. architecture, built form, materials, decoration, lighting, colour and texture) and how it relates to the character of its surroundings. The statement should also show how access considerations, such as circulation routes lighting and materials have informed the appearance of the proposal.

**Sustainability** - The Design and Access Statement should describe how the development will minimise resource consumption. Will developers undertake a BREEAM rating for proposed buildings? What level of commitment is there to energy conservation in the design, construction and operation of the building through the selection of materials, servicing strategies and orientation? How will the scheme facilitate waste reduction and recycling? Has there been consideration given to the use of grey water recycling? In the case of residential development, what level of the Code for Sustainable Homes will the scheme aim to achieve?



Use of photovoltaics in Bedzed, Sutton

## F Access Component.

The purpose of a design and access statement is also to explain how access will be provided that ensures that all users within the community will have equal and convenient access to buildings, spaces and the public transport network. The statement should include details regarding the flexibility of the development and its ability to adapt to changing requirements.

All proposals, whether for new developments or alterations to an existing building, should consider the implications of providing inclusive access from the start of the design process. The details of this should be submitted as part of any application to reflect this process.

Access refers to the links between the site and the local transport network, and also to social inclusion. Access is important. Firstly, developments that are easily accessed via the local transport network facilitate use. Secondly,

where links to sustainable transport like walking and public transport are good, new development can also play a part in reducing carbon emissions. Thirdly, accessible design is socially inclusive in terms of access to jobs, health, housing, education, shops and leisure. Within the design and access statement, access issues and constraints should be explored.

The statement should explain the approach adopted in relation to access and how the requirements of national and local guidance and policies have been taken into account. The statement should also provide details of the national standards used, for example British Standard BS 8300 2001: Design of buildings and their approaches to meet the needs of disabled people - Code of Practice. In addition the statement should provide details of any consultation undertaken in relation to issues of access and how the outcome of this consultation has informed the development proposals. It is important to note that the requirement for the access component of the statement relates only to "access to the development" and therefore does not extend to the internal access aspects of individual buildings.

Some of the matters that need to be considered include:

- Will the place be safe and easy for everyone to move around? Does the development include gateways, landmarks, identifiable nodes etc?
- Have the physical access needs of all sections of the community been taken into account, and has the policy approach and consultation process been clearly described?
- Is the development well linked into surrounding transport networks, making it accessible by more environmentally friendly modes such as public transport, cycling and walking?

Overall, the statement needs to include two potential aspects of access. That is not to say they are separate, and the statement should

show that all access issues have been considered together.

#### Vehicular and transport links

- Why have the access points and routes been chosen?
- How does the site respond to road layout and public transport provision?

#### Inclusive Access

- How can everyone get to and move through the place on equal terms regardless of age, disability, ethnicity or social grouping?

### 3.2 Design and Access Statements Accompanying an Outline Application

When the government introduced the formal requirement for Design and Access Statements, the rules about outline applications were also changed. Since the 10th of August 2006 outline applications must include a minimum level of detail on:

- what the buildings will be used for
- how many buildings there will be
- roughly how they will be laid out
- minimum and maximum building sizes, and
- where entrances to the site will be.

Design and Access Statements play a particular role in linking general development principles to final detailed designs. A statement accompanying an outline application must explain how the applicant has considered the proposal, and understands what is appropriate and feasible for the site in its context. It should clearly explain and justify the design and access principles that will be used to develop future details of the scheme. The Design and Access Statement will form a link between the outline permission and the consideration of reserved matters.

'The statement accompanying the outline application should explain and justify the decisions taken so far but, very importantly, it

must also explain the principles that will be followed when all the details are designed after permission is granted. The statement should set out the aims for the whole design, even if many of the details still have to be drawn up. The developer should keep within the parameters set out in the statement, and the outline permission may need to include conditions to make sure the ideas and aims in the statement are followed through as the design progresses. So, unless a new statement is produced, the original one accompanying the outline application will be very important when reserved matters are drawn up and agreed. When reserved matters are approved, it may be appropriate to place further conditions on the permission that relate to detailed aspects of the statement submitted with the original outline application.' (CABE 2006)

Where access is reserved in outline applications, the statement should still indicate the proposed points of access to the site. Statements accompanying such applications should, however, clearly explain the principles that will be used to inform the access arrangements for the final development.

Full details of the changes to reserved matters, and the minimum information that now needs to be submitted at the outline application stage can be found within the circular, *Guidance on changes to the development control system* and the related regulations (statutory instrument 2006 no.1062).



In this example the designer has integrated an access ramp into the overall design - thereby ensuring inclusive access.



### 3.3 Design and Access Statements Accompanying Applications for Listed Building Consent

Design and access statements are also required for listed building consent. These should be similar to statements for full applications, however there will be some differences due to the nature of this type of application. If a planning application is made at the same time as an application for listed building consent, then a joint statement should be submitted. This joint statement should satisfy the normal requirements in relation to a planning application plus those required for listed building consent.

The applicant should use the Design and Access Statement as an opportunity to explain and justify the alterations being proposed; ensuring that the significant fabric or features of the listed building are preserved and/or enhanced and its special historic or architectural importance is safeguarded for the future. A Design and Access Statement also gives an opportunity for the applicant to state what they were thinking when they designed the alterations and the options they have considered. Planners can then look at the statement and see where the scheme has complied with or departed from the relevant codes or policies.

A necessary starting point for the statement is a demonstration that the significance of the building, its component parts and features are understood. Basic information can be obtained from the List Description but depending on the scale and potentially damaging affects of the proposal, the services of an architectural historian may be required. Any particular physical features of the building that justify its designation as a listed building must be identified particularly if these are to be affected by the proposal. A photographic survey to record the historic fabric and features will be required. This will serve as an archive record of the building pre-alteration but will also serve to aid the planning officer in the appraisal of the

scheme. Wide angle photographs showing the building's setting or the context of a particular feature (within a room, for instance) will also be required.

The circular *Guidance on Changes to the Development Control System* (2006) states that: 'The design and access statement should explain the design principles and concepts that have been applied to the scale, layout and appearance characteristics of a proposal (information on use, amount and landscaping is not required for listed building consent design and access statements that do not also accompany a planning permission). In addition to following the broad approach in drawing up the design and access statement in relation to applications for planning permission, a design and access statement relating to listed building consent should include a brief explanation of how the design has taken account of paragraph 3.5 of PPG15 (*Planning and the Historic Environment*).'



Sunderland Old Post Office - High quality conversion of a listed building



The Planning (Applications for Planning Permission, Listed Buildings and Conservation Areas) (Amendment) (England) regulations 2006) provides detailed information on the requirements for Design and Access Statements for Listed buildings.

As with other Access Statements, the statements must illustrate the design principles and concepts that have been applied to the project in relation to scale layout and appearance.

The statement must specifically take account of the special architectural or historic importance of the building that justifies its designation as a listed building and the building's setting.

The Design and Access Statement should also include information on the colour, make and name of materials to be both internally and externally including roofing and the surfacing of outside areas such as car parks.

Similarly, the access component is broadly the same as for design and access statements accompanying applications for full planning permission, but again with reference to the special considerations set out above. For buildings where inclusive access is appropriate, the statement will need to address access to the building and its interior. The statement must show the proposed approach for balancing the protection of the building's character with access requirements. Where appropriate access is not achieved, the statement will need to provide solutions to minimise the impact on people with disabilities and provide services in other ways.

"It is important in principle that disabled people should have dignified easy access to and within historic buildings. If it is treated as part of an integrated review of access requirements for all visitors or users and a flexible and pragmatic approach is taken, it should normally be possible to plan suitable access for disabled people without compromising a building's special interest. Alternative routes or re-organising the

use of spaces may achieve the desired result without the need for damaging alterations." (*Paragraph 3.28, PPG 15*)

In order to ensure that the application for Listed Buildings consent and Planning applications contain all the required information, developers must refer to the document 'Best Practice Guidance on the Validation of Planning Applications' available at: [www.communities.gov.uk](http://www.communities.gov.uk)

Local Tyne and Wear Guidance is also available in: 'The Validation of Planning Applications Tyne and Wear', available at: [www.sunderland.gov.uk](http://www.sunderland.gov.uk)

### 3.4 Pre-application Enquiries

It is considered good practice to use design and access statements as an aid to pre-application discussions. An applicant may be requested to make a pre-application Design and Access Statement to explain the design principles on which the proposed development is based. A Design and Access Statement can be a cost effective and useful way to discuss a proposal throughout the design process. This will enable the local authority to give an informed response in respect to the main design and planning issues.

Typically, a pre-application Design and Access Statement will include the sections set out below.

#### Background information

Background information will generally include the site address, a location plan, a site plan, site photographs, an aerial photograph as well as basic site and project information.

#### Project brief

The project brief should clearly set out the aims and aspirations of the client and indicate how the principles of good design will be applied.

#### Policy review

This section should identify key national and local policies and guidance that are relevant to the development.

#### Site appraisal

An appraisal of the site and its context will identify important site characteristics and constraints. A thorough appraisal is fundamental to the design process.

#### Design concept

This section will include a written statement and illustrations in sketch form to demonstrate how the project brief, policy review and the site appraisal have informed the principal design concepts of the development.

Early consultation with the public and amenity groups will help to identify any key design or access issues or concerns and will help inform the design process. The level of consultation will depend on the type and scale of the proposed development. It is advisable that consultees are kept informed as the design proposals progress.

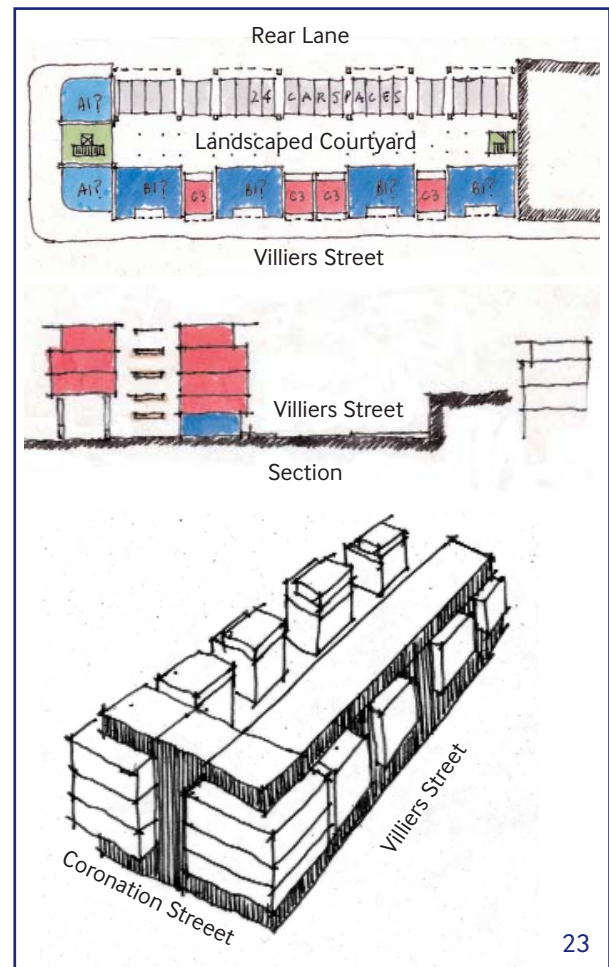

Design concept sketches do not need to include a huge amount of detail - simply show the design process. (Source - Fitz Architects).

## 4.0 Presentation

The applicant should choose the most effective form of presentation, as the contents of a design and access statement will vary according to the scale and nature of the development and the site's characteristics. The statement need not be an elaborate and lengthy document.

Illustrations must be easy to understand and clearly support the text. They may consist of photographs, sketches, figure / ground diagrams, photomontages, concept diagrams, computer based images and artist's impressions. The applicant may also submit models or photographs of models. The illustrations should aim to explain the design approach rather than duplicate planning application drawings. Irrespective of the scale of development, the design and access statement must be supported by good quality and easily understood graphics.

Additional supporting information may include case studies and illustrations of similar developments. These may be local, national or international examples.

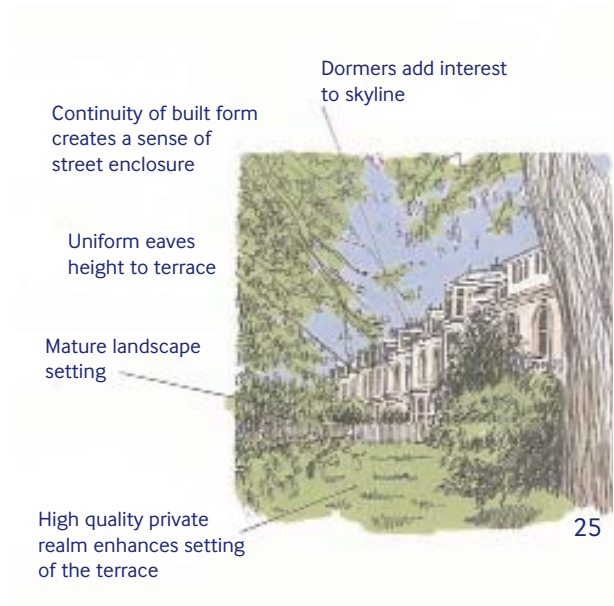

Development proposals should respond to and reinforce positive features of the local townscape and built form character. An appraisal of the local character may include annotated photographs, sketches and plans.

Farringdon Row



Sun Path (Source - Faulkner Brown Architects).

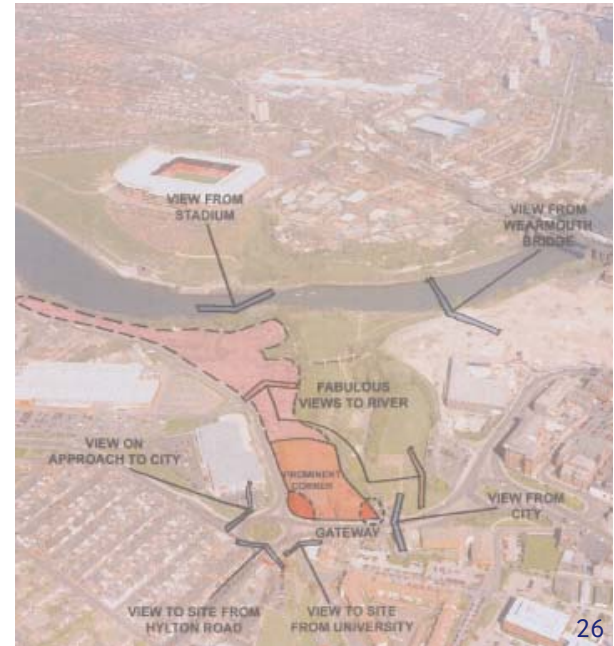

Visual Connectivity





27

Simple and legible cross sections show how the proposed development responds to the site topography and how it relates to existing buildings in and around the site.

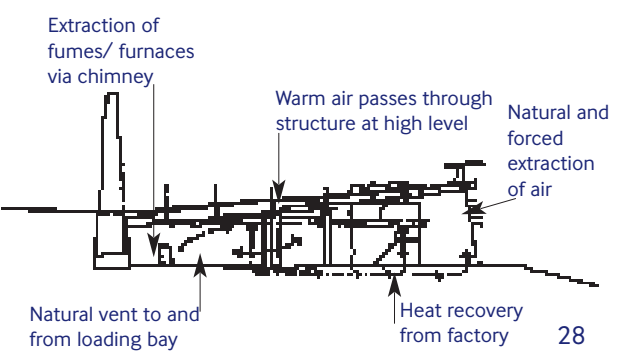

28

Working sketches and diagrams are a useful way of illustrating key building design and urban design concepts for the proposed development.

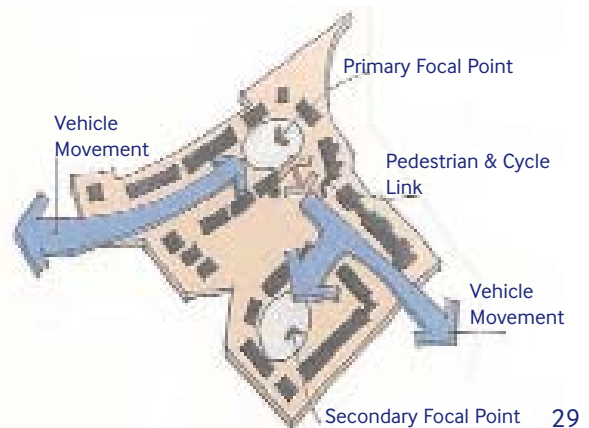

29

Simple diagrams can be used to illustrate key design principles such as the existing and proposed pattern of movement in and around the site of the proposed development.



30

Elevation drawings should show the proposed development in its context and demonstrate how it makes a positive response to the character of the local built environment. (Source Napper Architects).





A sketch layout can be a useful tool for discussing the design principles of a development proposal.

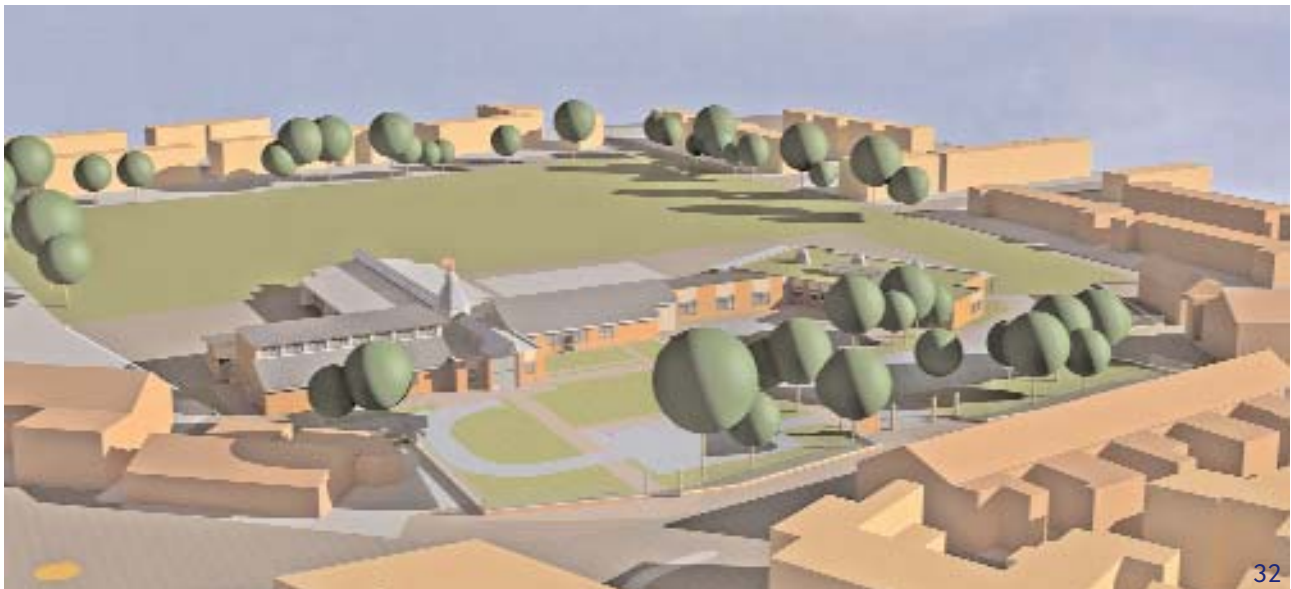

Hetton Lyons Replacement Primary School that shows development in context.

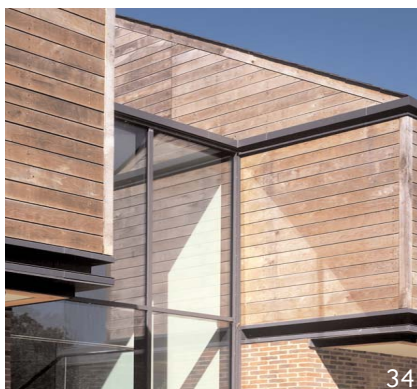

Photographs of proposed building elements can be beneficial

## 5.0 Further Guidance

*Access Statements: Achieving an inclusive environment by ensuring continuity throughout the planning, design and management of buildings and spaces.*

Disability Rights Commission, undated

*Bringing the DDA to life for small shops: Improving access to goods and services for disabled customers.*

Disability Rights Commission, 2003

*British Standard BS 8300:2001: Design of buildings and their approaches to meet the needs of disabled people - Code of Practice.*

British Standards Institution, 2001

*Code of Practice: Rights of Access, Goods, Facilities, Services and Premises.*

Disability Rights Commission, 2002

*Design and Access Statements - How to write, read and use them*

Campaign for Architecture and the Built Environment, 2006

*Design and Access Statement Writing Tool*

IGNITE, 2008  
[www.designstatement.co.uk](http://www.designstatement.co.uk)

*Designing for Accessibility.*

Centre for Accessible Environments, 2004

*Draft Code of Practice. Rights of Access: Services and Premises (Services to the Public, Public Authority Functions, Clubs and Premises)*

Disability Rights Commission, 2005

*Easy Access to Historic Buildings*

English Heritage, 2004

*Guidance on changes to the development control system*

The Department for Communities and Local Government, 2006

*Inclusive Mobility*

Department for Transport, 2005

*Inclusive Projects*

Disabled Persons Transport Advisory Committee, 2003

*Planning and Access for Disabled People: A Good Practice Guide*

Office of the Deputy Prime Minister, 2003

*Planning Policy Guidance 15: Planning and the Historic Environment*

Department of Environment & Department of National Heritage, 1994

*Planning Policy Statement 1: Delivering Sustainable Development*

Office of the Deputy Prime Minister, 2005

*Safer Places - the Planning System and Crime Prevention*

Office of the Deputy Prime Minister, 2004

*The Building Regulations 2000 - Access to and use of buildings. Approved Document M*

Office of the Deputy Prime Minister, 2003

*The Planning and Compulsory Purchase Act 2004*

*Town and Country Planning Act 1990*

*Town and Country Planning (General Development Procedure) (Amendment) (No.2) (England) Order 2005*

## 6.0 Glossary

### **The Applicant:**

The individual and/or persons who submit a planning application.

### **Density:**

The number of people or amount of building in any given area. Often expressed as dwellings per hectare.

### **Designated Area:**

Either a National Park, site of special scientific interest (SSSI), conservation area, area of outstanding natural beauty, World Heritage Site (WHS) or the Broads.

### **Full Planning Application:**

The most common type of application in which the full details of the proposal are all included for consideration. Full planning applications usually include householder applications.

### **Householder applications:**

A planning application for an extension or alteration to a single dwelling.

### **Inclusive:**

Making a place which everyone can use with comfort, dignity and convenience, regardless of their age, gender, ethnicity, disabilities or circumstances.

### **Infrastructure:**

The facilities people use every day, from roads and telephone lines to parks and schools.

### **Listed Building Consent:**

This is a special type of planning permission that may be required before a listed building can be altered, extended or demolished.

### **Non-renewable Energy:**

Energy released from finite energy resources that cannot be replaced once they are used, often because the energy source has taken millions of years to form (e.g. coal and oil).

### **Renewable Energy:**

Energy produced from sources of power that quickly replenish themselves or are continually available (e.g. wind power and solar energy).

### **Outline Consent:**

A form of planning consent designed to test the principle of whether or not a development is acceptable (see guidance).

### **Reserved matters:**

Issues not addressed within an outline planning application, but which will be approved at a later date.

### **Solar gain:**

The energy used by a building that it takes directly from sunlight.

### **Stakeholders:**

Individuals or groups that have a particular interest in an application or will be affected by it.

### **Street Furniture:**

Seats, bins, lights, plant holders, signs, etc that are placed in public areas.

### **Sustainability:**

The concept of meeting the needs of the present generation without compromising the ability of future generations to meet their needs.

### **Tree Preservation Orders:**

Used to protect specific trees or a particular area, group or woodland from deliberate damage and destruction. TPOs can prevent the felling, lopping, topping, uprooting or otherwise wilful damaging of trees without the permission of the Local Planning Authority.

### **UDP:**

Sunderland City Council's Unitary Development Plan.

### **Vernacular:**

Local architectural styles, materials, details or traditions.

## 7.0 Images within the document

1	Sunderland City Council
2	CABE
3	CABE
4	Robinsons Landscape
5	Sunderland City Council
6	CABE
7	Sunderland City Council
8	sunderland City Council
9	Reid Jubb Brown
10	www.land+living
11	www.land+living
12	Sunderland City Council
13	Sunderland City Council
14	Sunderland City Council
15	Nathaniel Lichfield and Partners
16	Nathaniel Lichfield and Partners
17	Nathaniel Lichfield and Partners
18	Planning Policy Statement 1
19	wwwland+living
20	CABE
21	AJ Specification
22	Sunderland City Council
23	Fitz Architects
24	Sunderland City Council
25	Faulkner Brown
26	Faulkner Brown
27	Napper Architects
28	Napper Architects
29	Napper Architects
30	Napper Architects
31	Richard Partington Architects
32	Sunderland City Council
33	AJ Specification